

multipole radiation

www.hyperfinecourse.org

---

---

---

---

---

---

---

---

multipole radiation  
for **CLASSICAL** systems

---

---

---

---

---

---

---

---



---

---

---

---

---

---

---

---

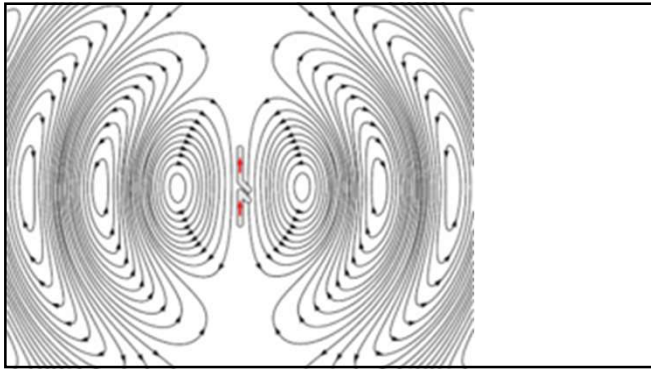

---

---

---

---

---

---

---

---

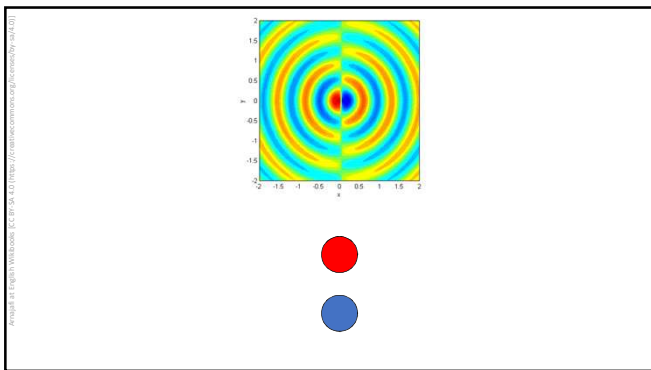

---

---

---

---

---

---

---

---

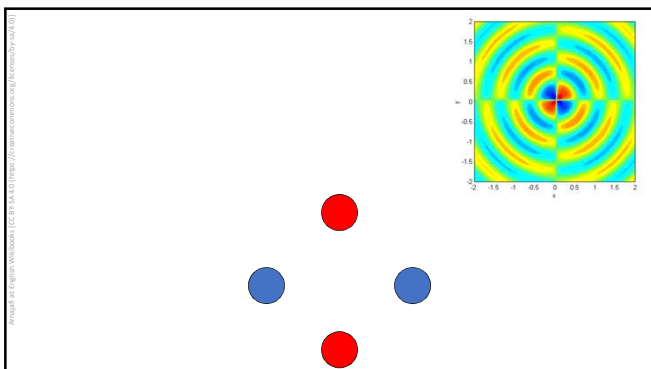

---

---

---

---

---

---

---

---

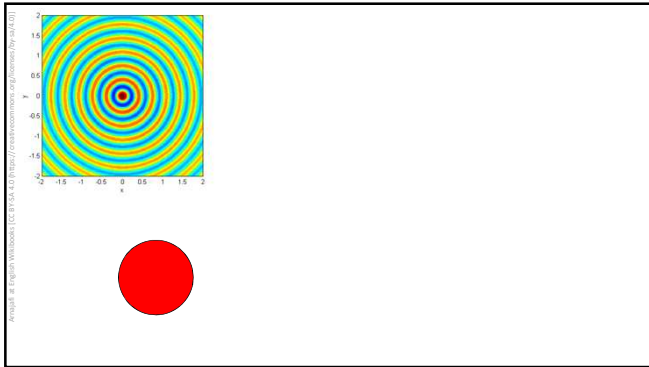

---

---

---

---

---

---

---

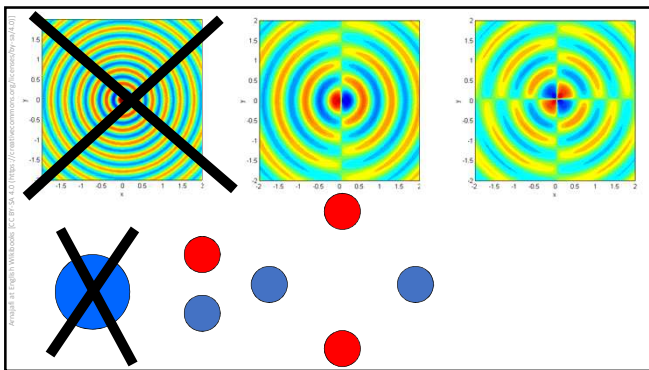

---

---

---

---

---

---

---

multipole radiation  
for **QUANTUM** systems

---

---

---

---

---

---

---

Why is an oscillating multipole not a good model for a decaying nucleus emitting radiation?

---

---

---

---

---

---

---

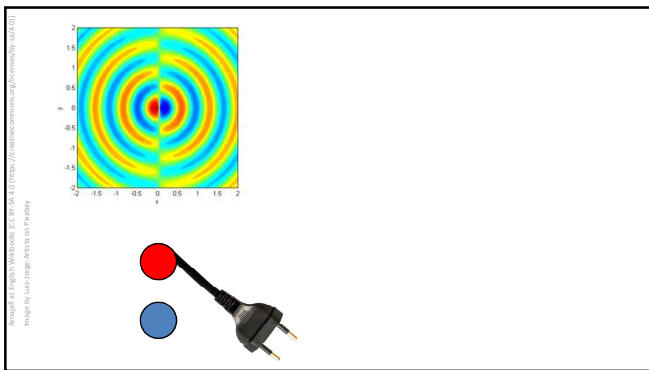

---

---

---

---

---

---

---

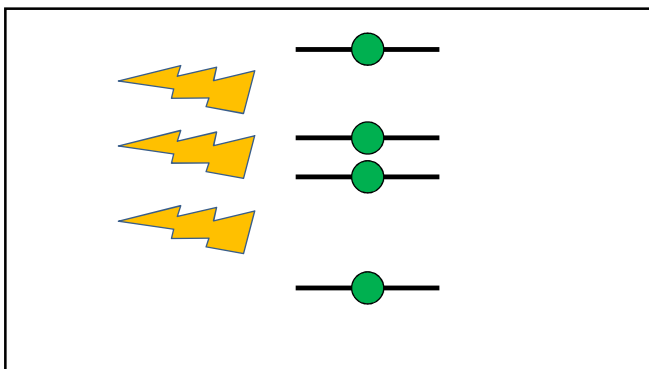

---

---

---

---

---

---

---

Why is an oscillating multipole not a good model for a decaying nucleus emitting radiation?

1. a nucleus is not "powered"

---

---

---

---

---

---

---

---

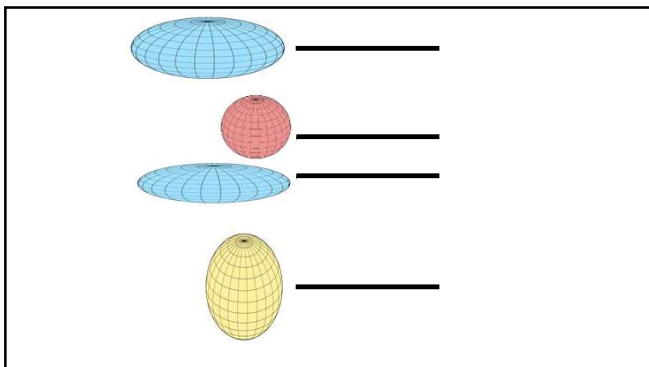

---

---

---

---

---

---

---

---

Why is an oscillating multipole not a good model for a decaying nucleus emitting radiation?

1. a nucleus is not "powered"

2. a nucleus decays from one multipole moment to another, it is not an oscillating multipole moment.

---

---

---

---

---

---

---

---

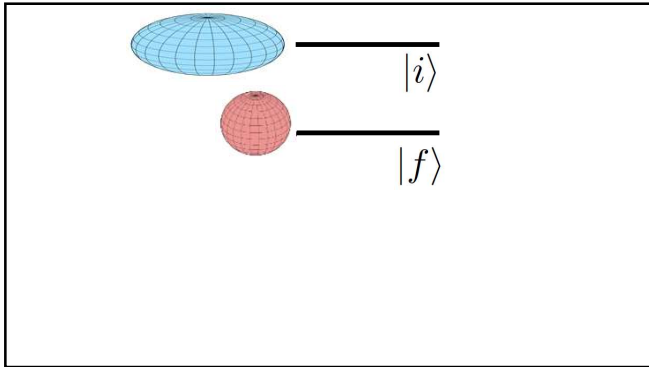

---

---

---

---

---

---

---

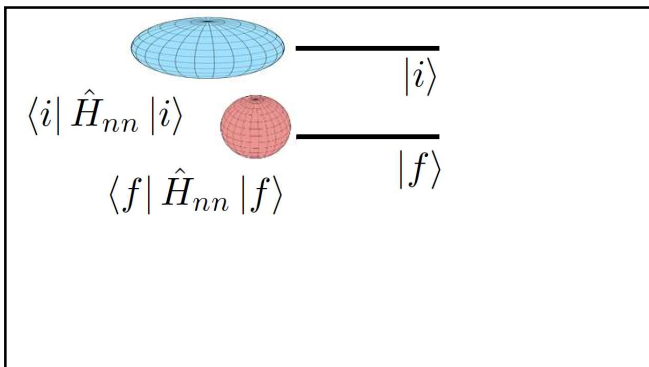

---

---

---

---

---

---

---

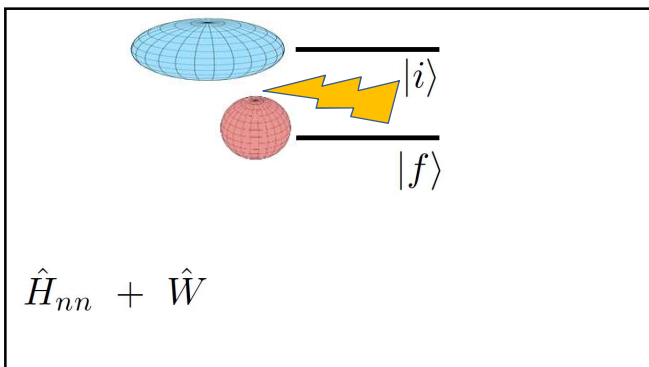

---

---

---

---

---

---

---

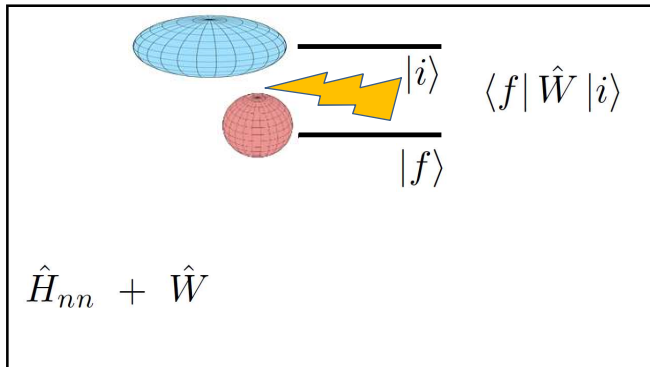

---

---

---

---

---

---

---

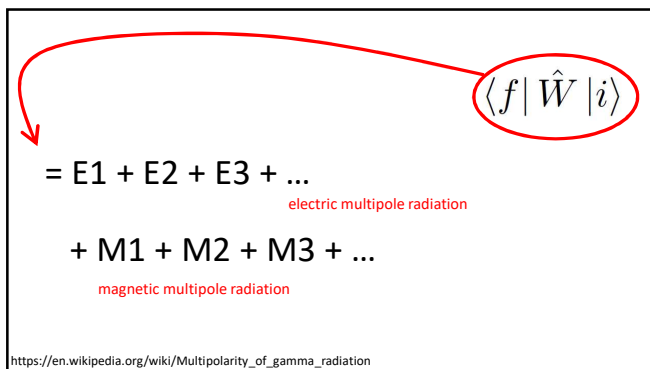

---

---

---

---

---

---

---